



IMPACT

Features and Benefits

- Standard Color – light gray with a high gloss finish
- Best material – bases, opaque covers and clear covers are all made of high-impact, UV resistant polycarbonate
- Easy ordering – One part number equals one completely assembled enclosure
- Super easy use – mounting flanges integral, so no extra hardware needed
- Flexible Interior Mounting – bosses on rear wall and lid of opaque enclosure provide multiple mounting options for din rail, back panels, or other components
- Advanced face plate mounting system – Brand new completely unique and easy
- Secure – Choose your level of protection: pad lockable, tamper screw or tamper tag capable
- Frequency Friendly – Available with absolutely no metals of any kind on the enclosure which is extremely favorable for sending and receiving wireless signals
- UL-50 / c-UL Listed (file # E207562)

Our Impact Line enclosures are the most versatile, feature packed, aesthetically pleasing, Nema UL rated, non-metallic enclosures available. Features like extremely durable, UV resistant, wide temperature range, easy to machine, lighter than other non-metallic or metal materials, the “Made in USA” Impact Line enclosures provide great value to any application.

Mechanical and Thermal	Test Spec.	Unit	Impact Line
Instrumented Dart Impact @ 73° F		in/lb.	565
Falling Ball Impact @ 73° F	UL-746	in/lb.	900
Deflection Temperature @ 264 psi	ASTM D648	Deg. F	270
Modulus of Elasticity	ASTM D790	ksi	340
Temperature Range		Deg. F	-40 to 265



Atex pending contact factory for details

Flammable / UV Ratings	Test Spec.	Unit	Impact Line
Flame Rating - UL	UL 94	-	5VA
Outdoor UV Exposure	UL	-	f1

P5053	4X IP66	6P IP68	Clear Cover	Opaque Cover	Integrated Mounting Flange	Standard Hinge	Low Profile Hinge	Integrated Locking Latch	Stainless Steel Locking Latch	Non-Metallic Locking Latch	Face Plate Mtg System*
P5053	✓	✓		✓	✓	✓		✓			✓
P5053C	✓	✓	✓		✓	✓		✓			✓
P5053LL	✓			✓	✓	✓			✓		✓
P5053CLL	✓		✓		✓	✓			✓		✓
P5053LP	✓	✓		✓	✓		✓	✓			✓
P5053LPC	✓	✓	✓		✓		✓	✓			✓
P5053LPLL	✓			✓	✓		✓		✓		✓
P5053LPCLL	✓		✓		✓		✓		✓		✓
P5053NL	✓			✓	✓	✓				✓	✓
P5053CNL	✓		✓		✓	✓				✓	✓
P5053LPNL	✓			✓	✓		✓			✓	✓
P5053LPCNL	✓		✓		✓		✓			✓	✓

* Sold separately





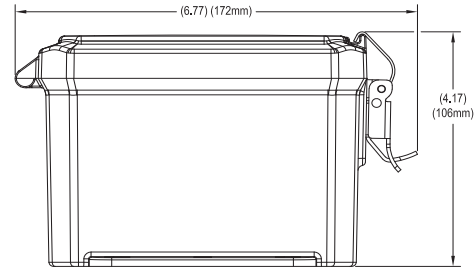
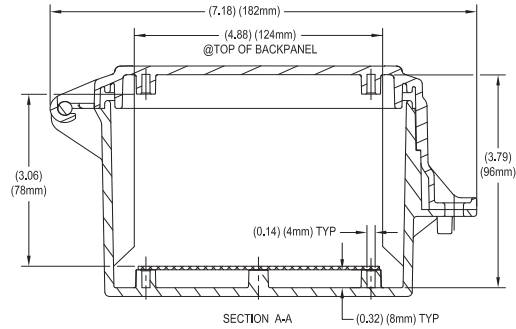
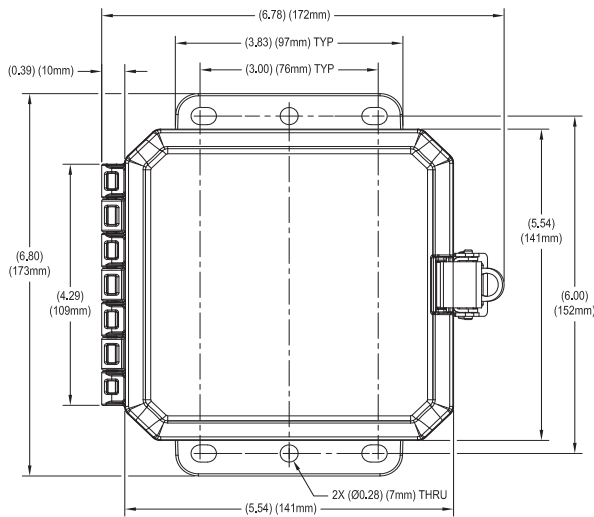
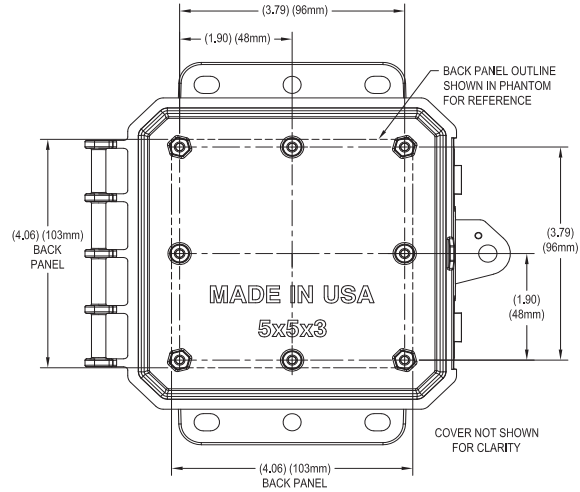
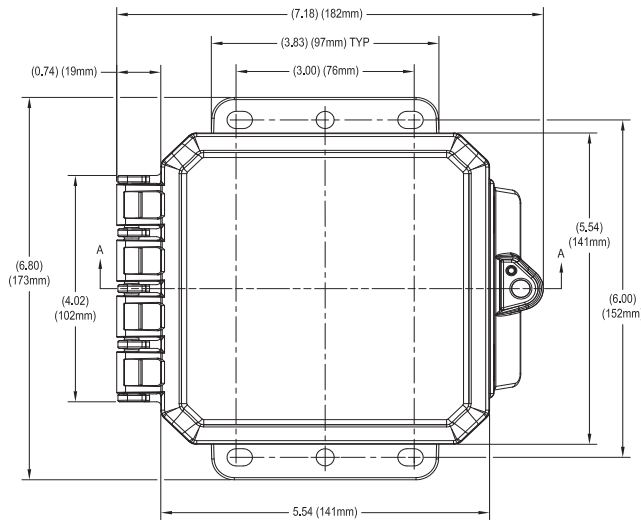





5X5X3 IMPACT LINE



Register online to download this drawing off the Integra website at www.integraenclosures.com | Your company's logo or other information on the lid. Consult factory for details.

Accessories for 5x5x3 Impact (For complete accessories, see page 52-54)

 <p>Back Panels ABP55-IMP - Aluminum panel SBP55-IMP - Steel panel PVCBP55-IMP - PVC panel</p>	 <p>Aluminum Face Plate System AFP55-IMP - Aluminum face plate and FPSK-55 mounting kit AFP55-IMP - Aluminum face panel only</p>	 <p>Face Plate Support Kit CB53-IMP - Support kit contains 4 support panels and 8 screws.</p>
 <p>Air Vents VENT 3 - Aluminum louvered VENT 2 - Outdoor labyrinth</p>	 <p>Steel Face Plate System SFP55-IMP - Steel face plate and FPSK-55 mounting kit SFP55-IMP - Steel face panel only</p>	 <p>Hole Plugs Liquid tight thru plugs. IP67 and UL rated. See page 53 for more details.</p>
 <p>Din Rail DIN 5-IMP - 2 rails, 4 screws</p>	 <p>Pole Mounting Kit PMKG-25-IMP - 2" pole PMKG-35-IMP - 3" pole PMKG-45-IMP - 4" pole PMKG-125-IMP - 12" pole</p>	 <p>Cord Grips IP68/NEMA 4X/6P rated See page 53 for more details.</p>